

ЧАСТИ В КОМПЛЕКТА

820 Straight

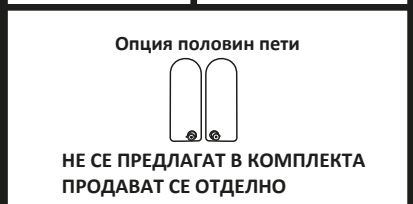

824 Straight

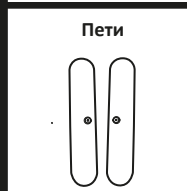
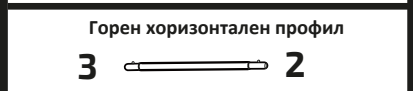
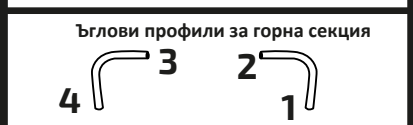
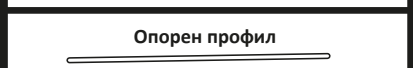
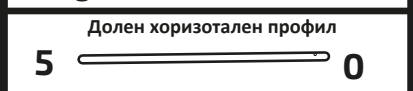
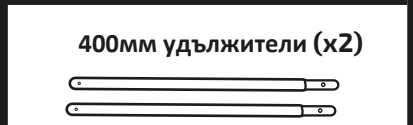

ЗАБЕЛЕЖКА: Удъжителите се предоставят в комплекта на 824 Straight рамка

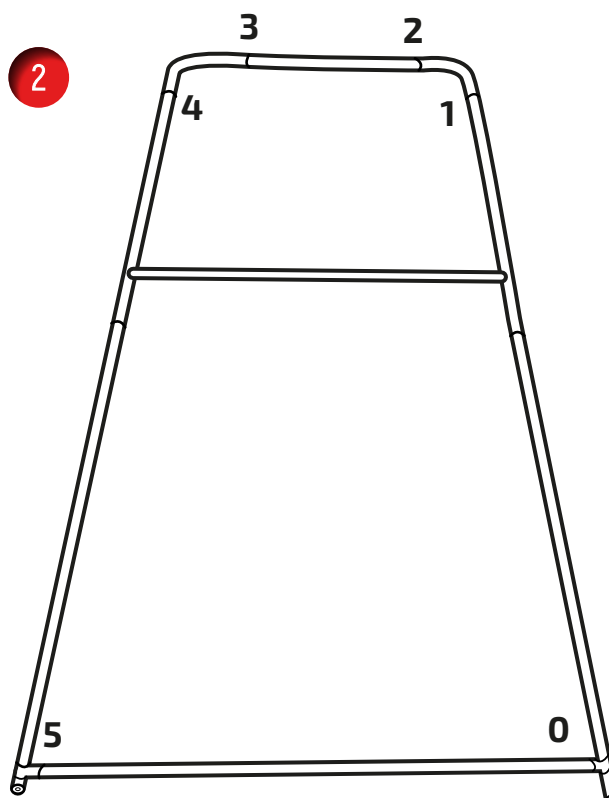
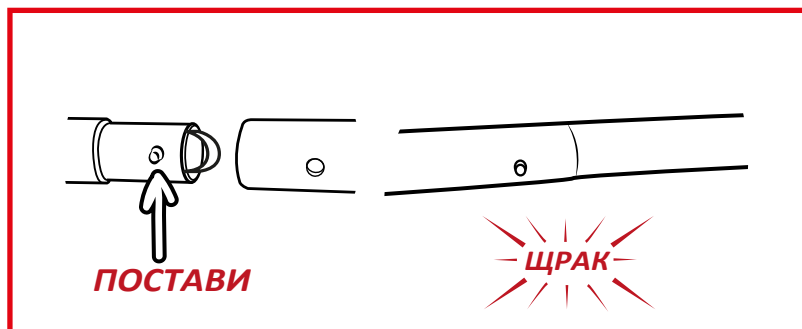
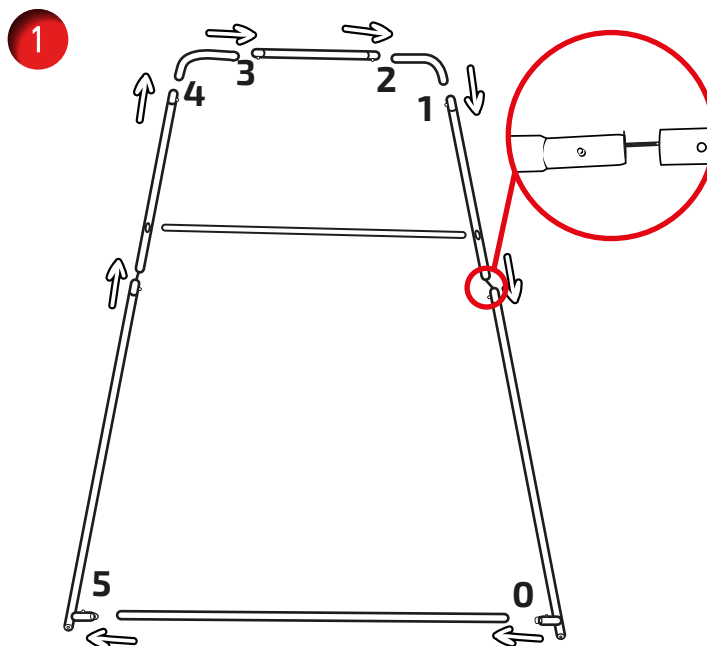

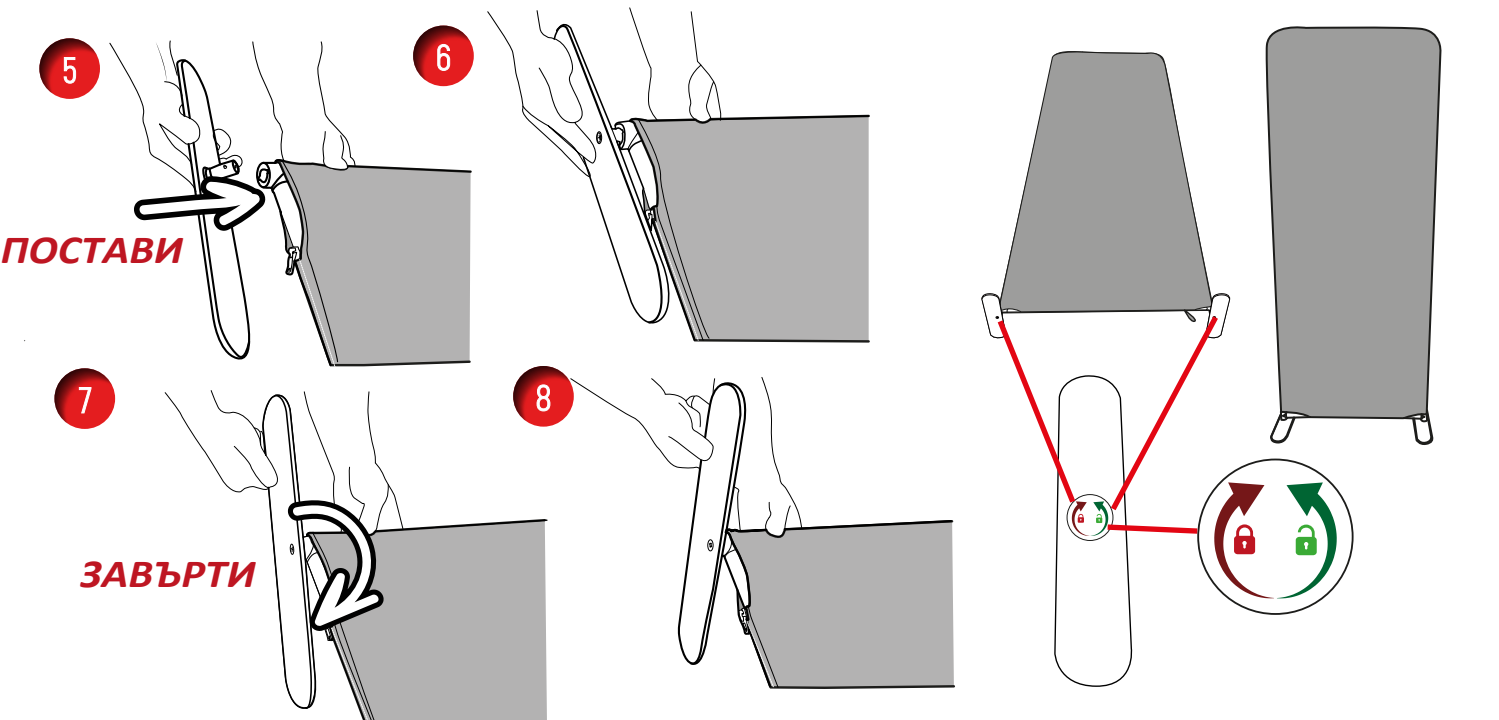
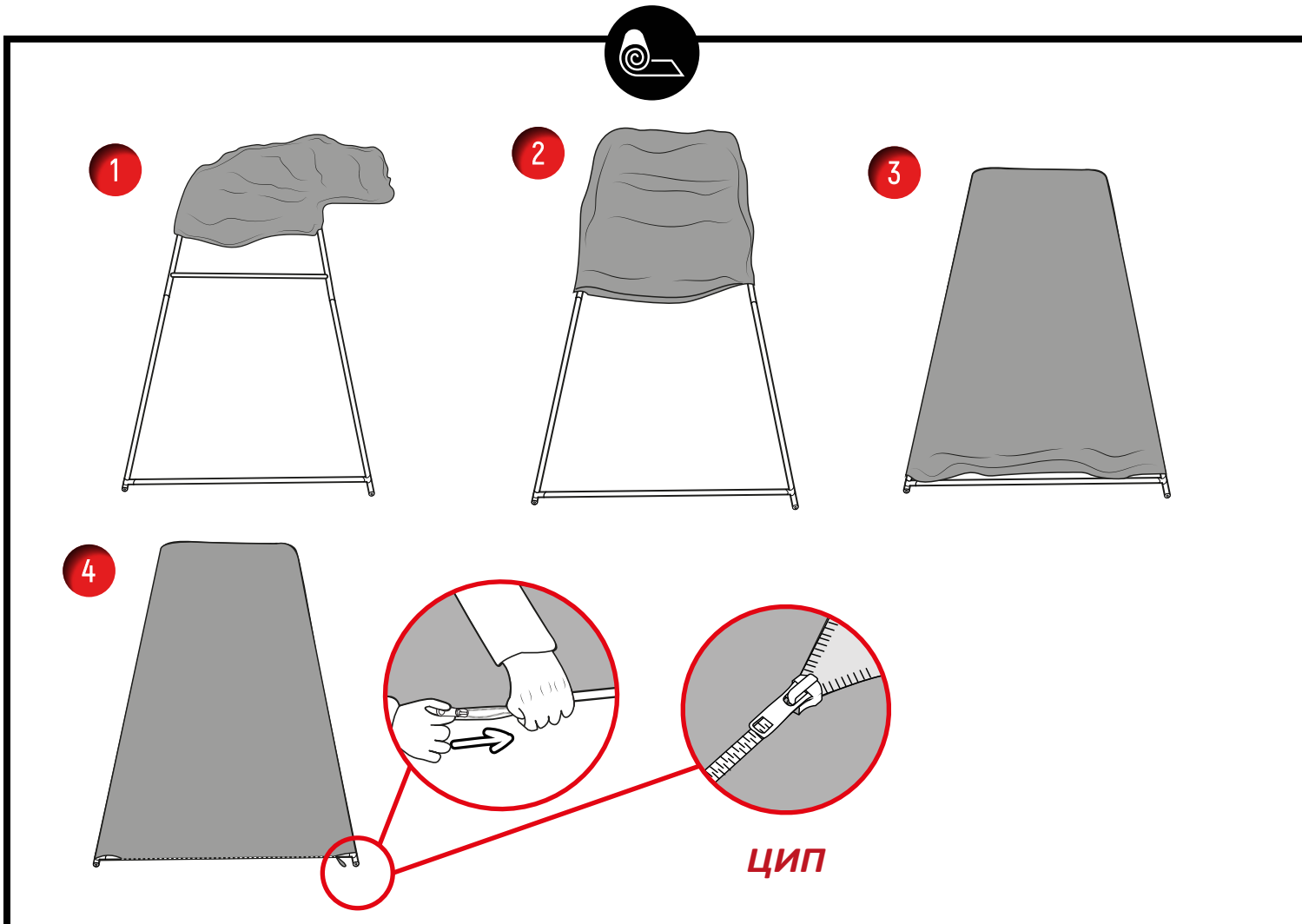

Завърти по часовниковата стрелка за заключване
 Завърти обратно на часовниковата стрелка за отключване

ЗАБЕЛЕЖКА: Стикера на петата указва посоката на заключване **ЗАКЛЮЧЕНО/ОТКЛЮЧЕНО**

ЗАБЕЛЕЖКА: ДВА НАЧИНА ЗА МОНТАЖ НА ПЕТИТЕ
 (ВИЖ ОПЦИЯ 1 ЗА ВТОРИЯТ НАЧИН)



ОПЦИЯ (УДЪЛЖИТЕЛИ)

ЗАБЕЛЕЖКА: УДЪЛЖИТЕЛИТЕ СЕ ПРЕДЛАГАТ С 824 ПРАВА РАМКА

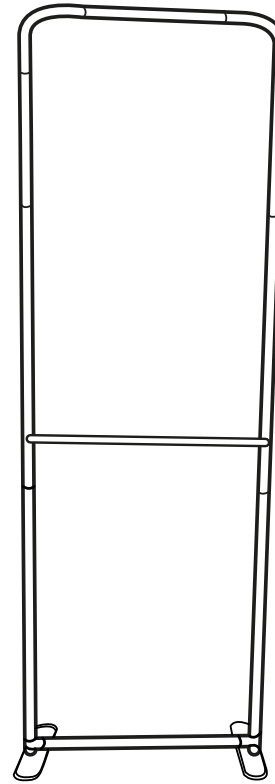
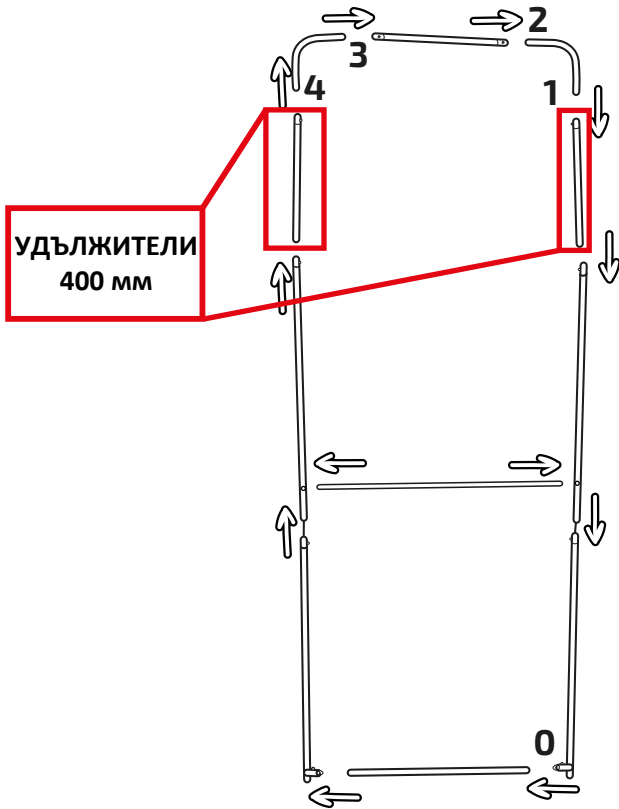

ОПЦИЯ (ПОЛОВИН ПЕТА)

ОПЦИЯ 1 ЗАБЕЛЕЖКА: ПОЛОВИНКАТА ПЕТА МОЖЕ ДА БЪДЕ МОНТИРАНА ПО ДВА РАЗЛИЧНИ НАЧИНА

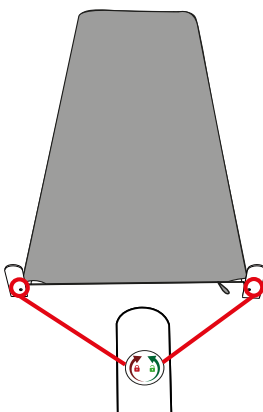
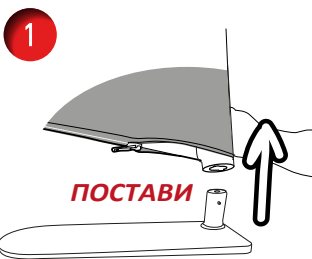

Завърти по часовниковата стрелка за заключване
Завърти обратно на часовниковата стрелка за отключване

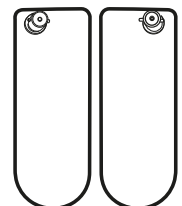



ОПЦИЯ 2

1

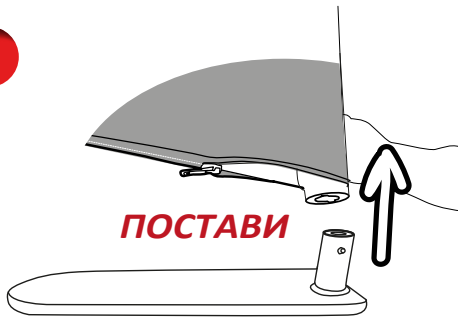

2



3

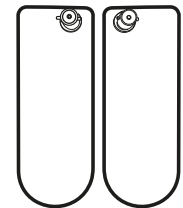
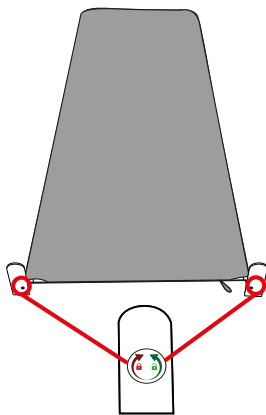

Завърти по часовниковата стрелка за заключване Завърти обратно на часовниковата стрелка за отключване



СВЪРЗВАНЕ НА НЯКОЛКО РАМКИ

ЗАБЕЛЕЖКА: ВТОРАТА РАМКА 824 STRAIGHT НЕ СЕ ПРЕДЛАГА В КОМПЛЕКТА

Премахнете едната пета на втората рамка и подравнете с петата на първата рамка

ЗАБЕЛЕЖКА:
Спазвайте същата последователност и при монтаж с половин пета

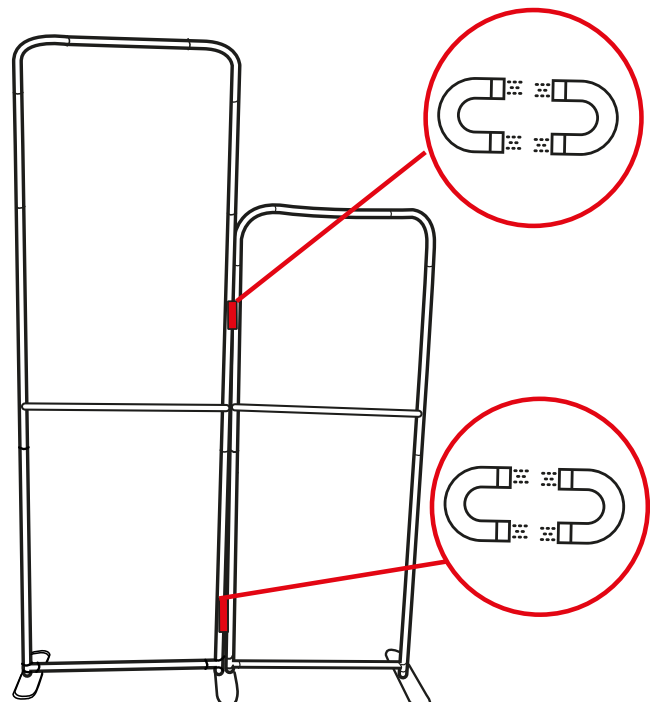
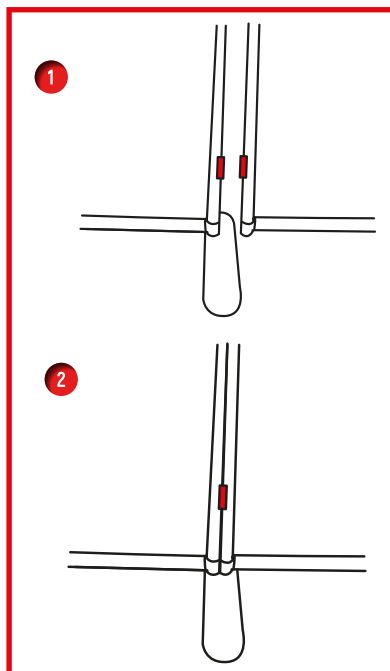

824 права рамка и 820 права рамка