

Modulate 824 (Slope 1)

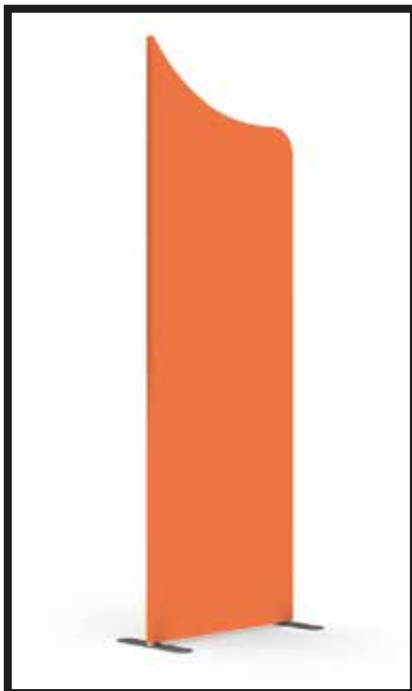

ЧАСТИ В КОМПЛЕКТА

Горен хоризонтален профил



Ъглов профил за горна секция



Вертикални профили

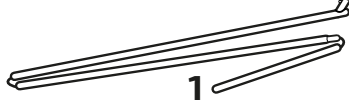

Опорен профил



Долен хоризонтален профил

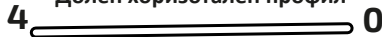

Пети

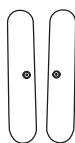

Ръкавици



Опция за полвинки пети

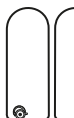

НЕ СЕ ПРЕДЛАГАТ В КОМПЛЕКТА
ПРОДАВАТ СЕ ОТДЕЛНО

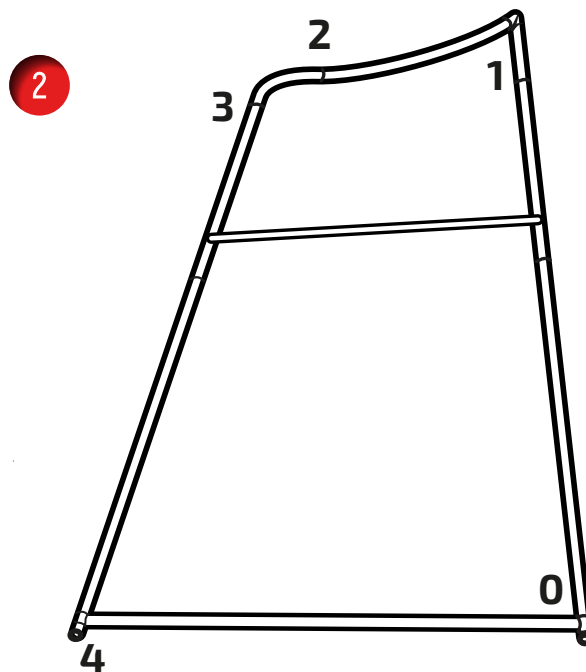
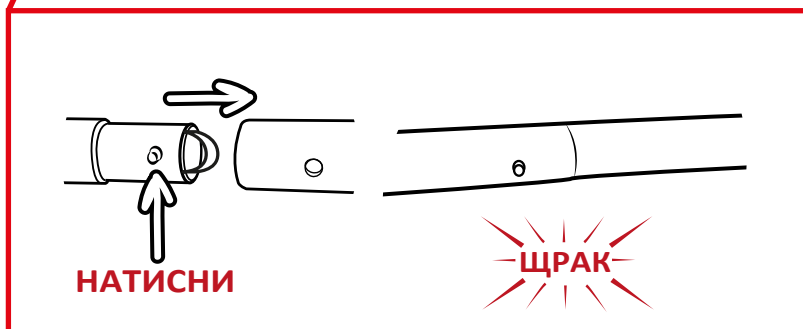
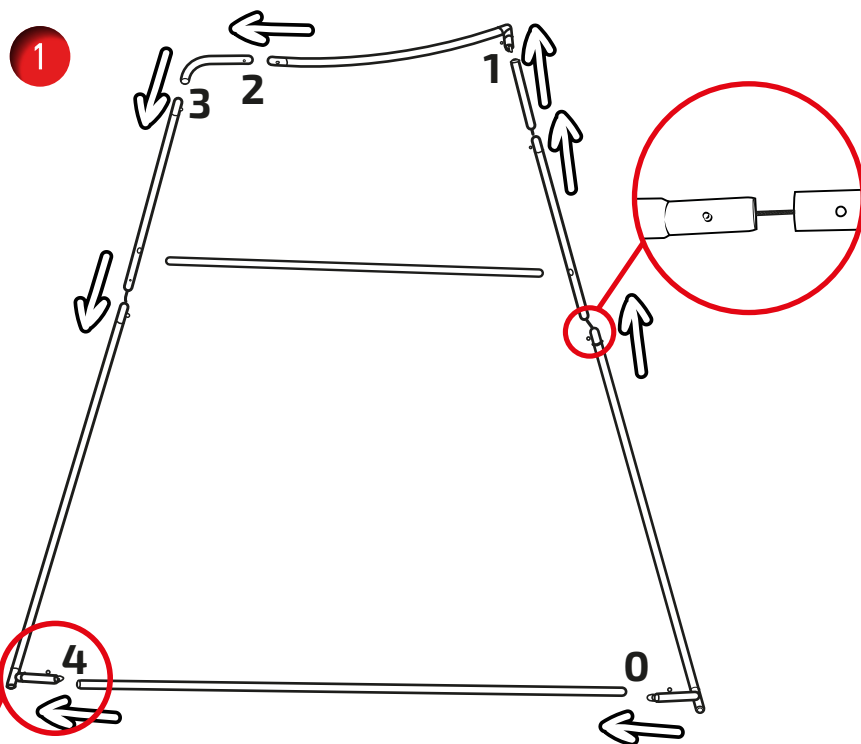

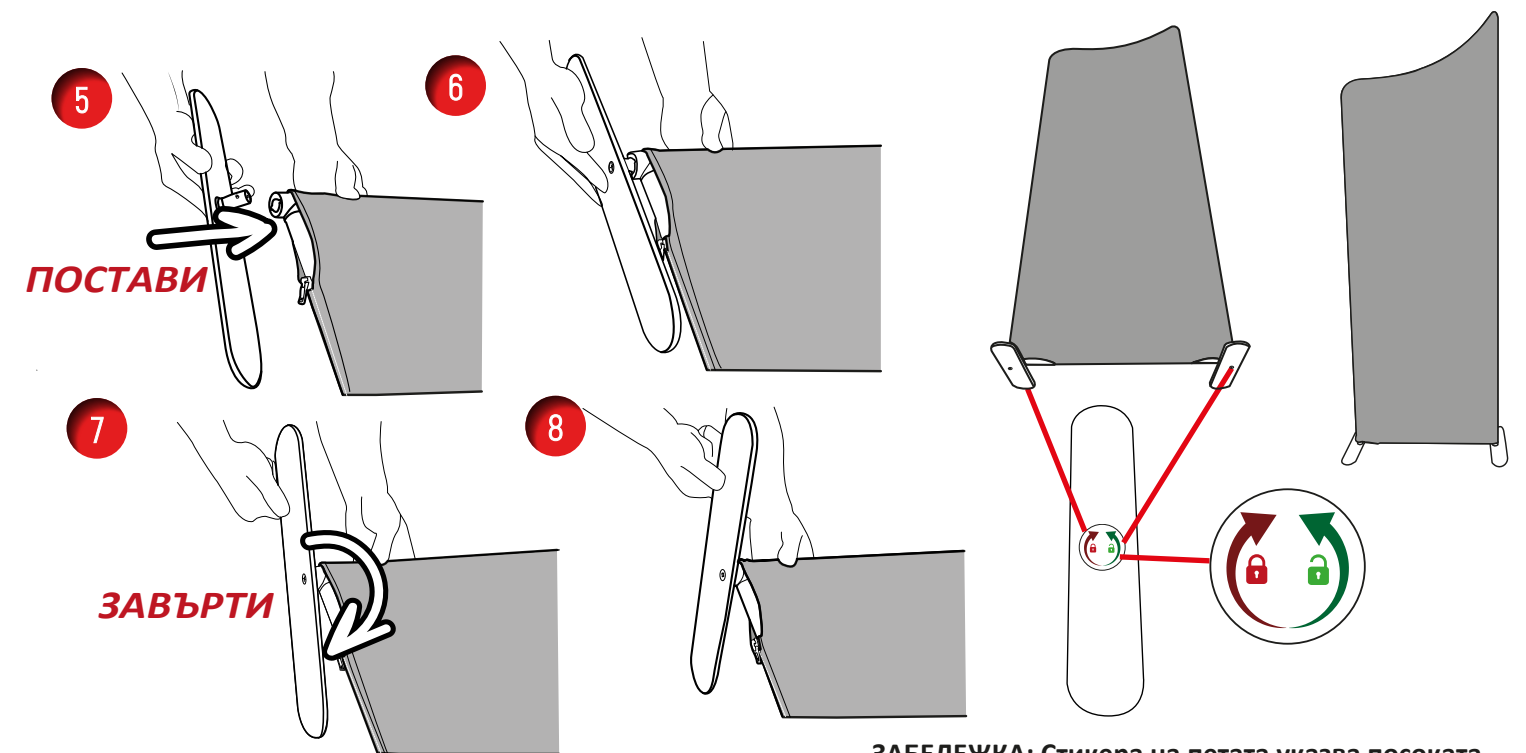
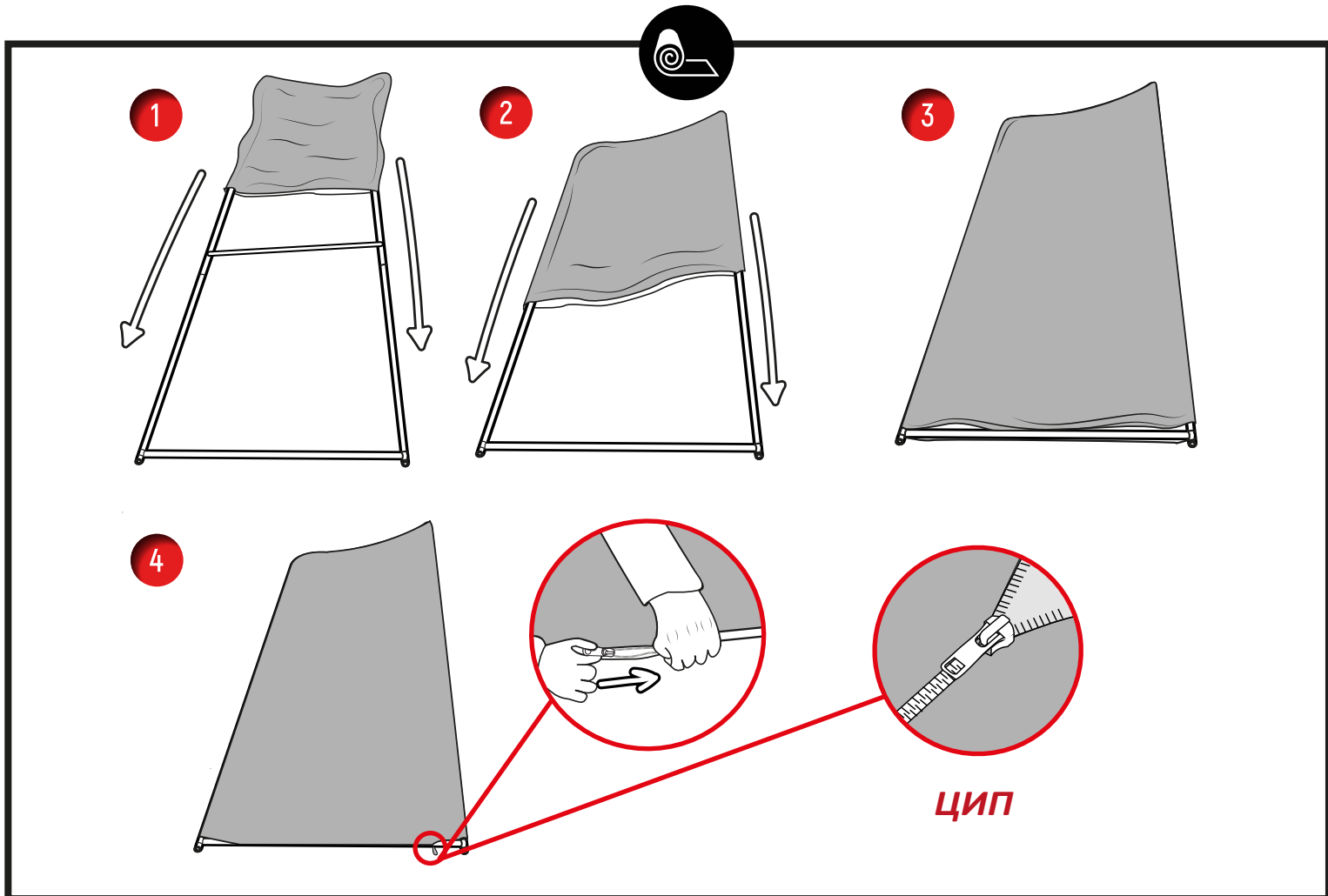

ЦИП

ПОСТАВИ

ЗАВЪРТИ

ЗАБЕЛЕЖКА: Стикера на петата указва посоката на заключване **ЗАКЛЮЧЕНО/ОТКЛЮЧЕНО**

ЗАБЕЛЕЖКА: ДВА НАЧИНА ЗА МОНТАЖ НА ПЕТИТЕ (ВИЖ ОПЦИЯ 1 ЗА ВТОРИЯТ НАЧИН)

Завърти по часовниковата стрелка за заключване
Завърти обратно на часовниковата стрелка за отключване



ОПЦИЯ (ПОЛОВИН ПЕТА)

ОПЦИЯ 1

ЗАБЕЛЕЖА: ПОЛОВИНКАТА ПЕТА МОЖЕ ДА БЪДЕ МОНТИРАНА ПО ДВА РАЗЛИЧНИ НАЧИНА



ПОСТАВИ



ЗАВЪРТИ

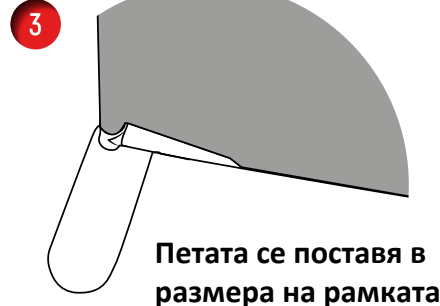

Петата се поставя в размера на рамката

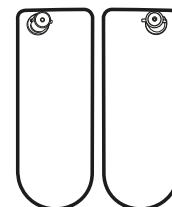

Завърти по часовниковата стрелка за заключване
Завърти обратно на часовниковата стрелка за отключване

ОПЦИЯ 2



ПОСТАВИ



ЗАВЪРТИ



Петата се поставя извън размера на рамката

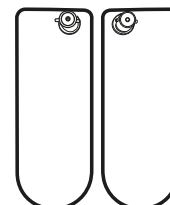

Завърти по часовниковата стрелка за заключване
Завърти обратно на часовниковата стрелка за отключване

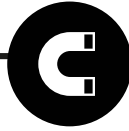

МОНТАЖ НА НЯКОЛКО РАМКИ ЕДНА ДО ДРУГА ЗАБЕЛЕЖКА: 420 Straight НЕ Е ВКЛЮЧЕНО В КОМПЛЕКТА

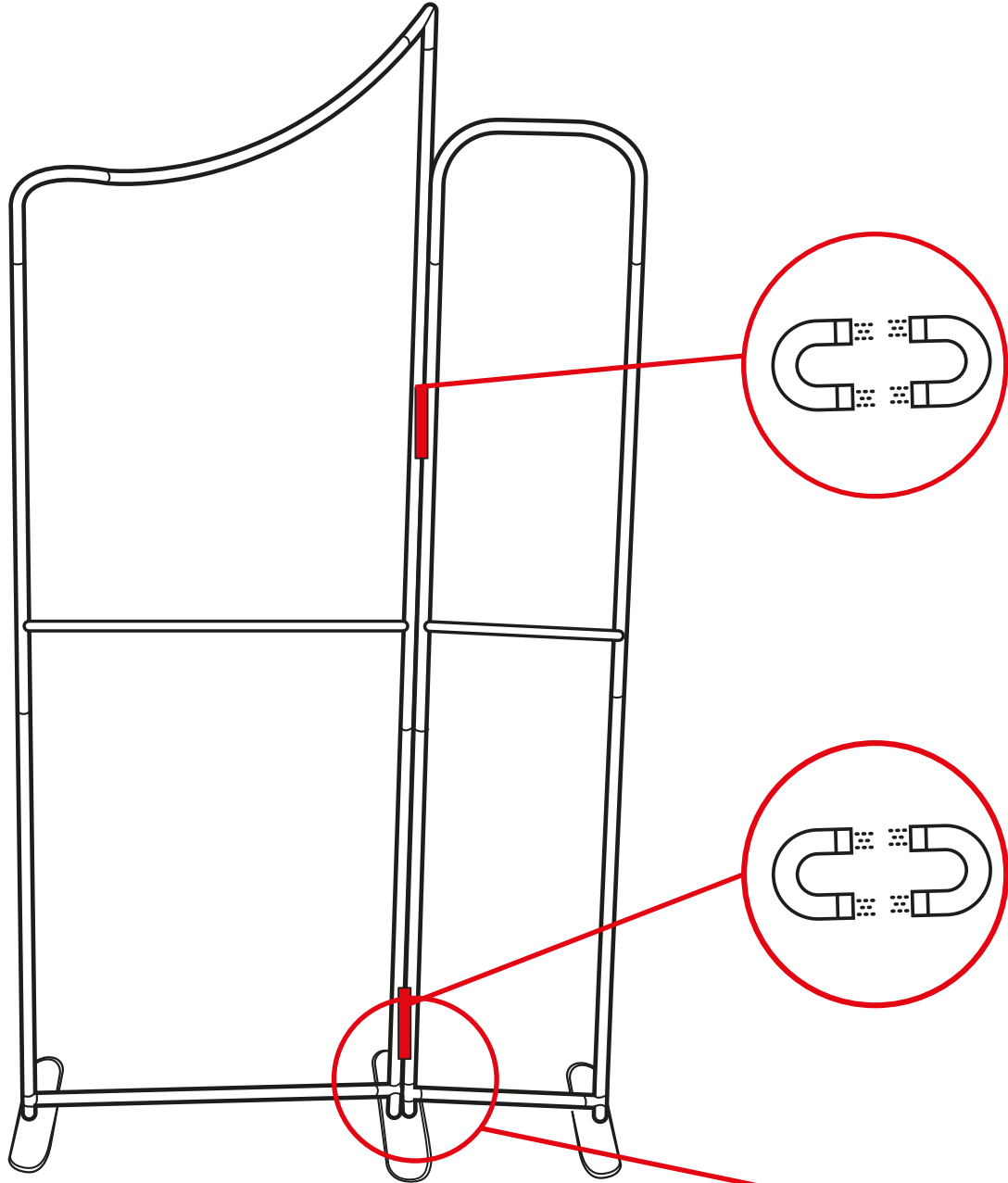

824 Slope 1 рамка и 420 Straight рамка

Премахнете едната пета на втората рамка и подравнете с петата на първата рамка

ЗАБЕЛЕЖКА: Спазвайте същата последователност и при монтаж с половин пета

